

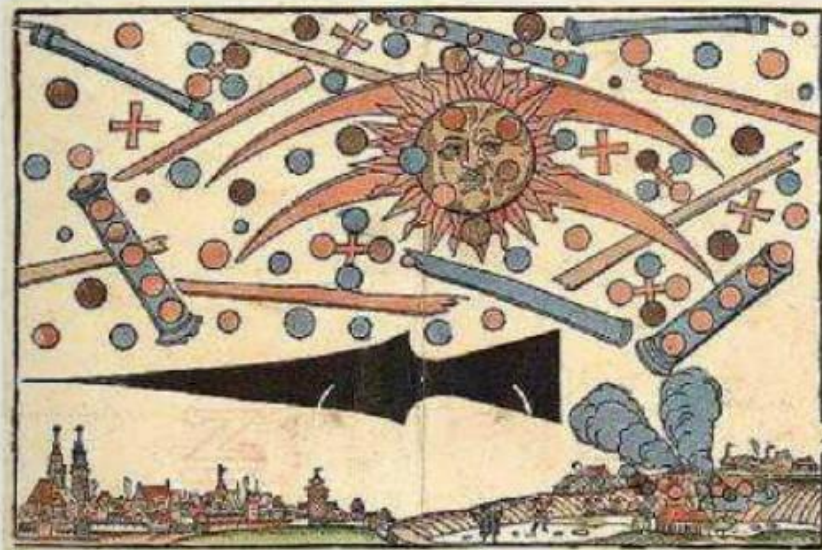

# INTRODUCTION TO THE ALIEN RACES BOOK







ARB  
DS

Petro started reading/translating some of them and we realized that there was a lot of interesting, intriguing and even top-secret (at least at one time) documents !

So we asked his father if we could keep the boxes for ourselves...he agreed and...we had to rent a van to take everything back to home with us.

Week after week, in our houses but mainly on the weekends, we went through all of the documents, translating them, cataloguing them by subject matter, or dates and places, etc..

As, due to work, we were apart quite often, we also did a lot of work on line.

That's when we found THE BOOK...the book that lead to the videos I published.. (this one book that we had is undated and looks "modern", but we did find the cover -only the cover- for the same book but dating back to 1951 !)

We called his father later that year and asked him about the book...and he filled in the missing information...he said that amongst high ranking political officials there had always been the rumor of alien contact, but nothing concrete...

He said that he had received the book years before from one of his life-long diplomat friends and had been updating the book until recently with information that friends of his sent him, or when they would get together to talk about "old times".

That information (regular updates) was sent to him by mail, phone or online.

He still gets regular updates that transmits to me.



ARB  
DS

The book has hundreds of side-notes on the pages (updates), small papers with related miscellaneous info attached to pages, photos stapled to them, etc...that is how we found out about relatively recent visits from aliens, their numbers, where it happened, etc...they had been updating the information they could get regularly.

BUT he also said that there were only a handful of people that were in the "know" back then (USSR days)...the leader of the communist party and a couple of advisers, 5 or 6 SMERSH agents (maybe more, up to 12), the commander of the armed forces AND the commanders of the 3 armed forces branches (army, air-force and navy) and maybe a couple of scientists...

He said that most likely there were more people in the know, specially in the military, but he could not confirm that ! (him and his friends did not recognize some of the names mentioned on the book)

People have asked me about some of the illustrations of certain Alien Races on the book...this because some of them were literally copied off movies and/or video games (not all).

Me and Petro asked ourselves the same thing, as we recognized some of them...and we did contact his father in order to get an answer.

He told us that over the years the people that were adding/updating/printing the book had been using alien images from the media when they did not have a real photo or a drawing from the witnesses...

So sometimes they used images from movies and video games that better described the Alien Race in question...this according



to the witnesses testimonies (description of their encounters).

However he did say something else...something extremely interesting.

He told us that amongst high-ranking diplomats there has been much "solid" discussion and debate about "a plan" involving certain media (from online to paper to hollywood to the video game industry) and certain security departments (specially from Japan, China, Canada, USA and Europe) in order to use the "right" (to them) images to describe the appearance of aliens...

All the media involved was (in the end...either directly or because they owned the "mother" companies) owned for no more than 5 people...and that this was a concerted effort in order to get people (human-kind) used to the appearance and presence of aliens...amongst us!

He (Petro's father) also told us that some of the alien races images used in video games (and other media) were used in the book PRIOR to the release of the games and/or movies...

Him and some of his friends had knowledge that some of those security departments had actually created some of the images and then "released" them to the proper channels...in order for those images to be known to the general public.

This, obviously, we could not confirm...except for one of the images on the book...the aliens used in the movie "Independence day" were known before the making (not even close) of the movie...by at least 8 years !

Also, some of the photos on the ARB, had been tampered with...



And so, there you have it...the "story" behind the ALIEN RACES RUSSIAN SECRET BOOK !

At least some of it...

I hope you enjoy the book and all the revelations contained in it.



this book is dedicated to the memory of

PETRO



The ARB has been re-edited (information always being updated in all aspects, from new alien races to new reports and photos or illustrations) at least 12 times. That we know the first edition was printed in 1946 or early 1947. Then new editions were printed: 1951 (I have the cover, just the cover, of that one), 1959, 1968, 1971, 1980...all the way to (we believe) 2011.





ARB  
DS



### THE LOST COPY

In the 1980's a copy of (edition) of this book was found on a field in Buryatia (east Siberia).

Thay copy ended up in the hands of a KGB agent with friends in the media.

After the collapse of the USSR some of the information (and images) in the book were leaked (sold?).

Years later the information and some of the images started appearing in tv series and video games.

"Mass effect" being the most well known...

(this information was handwritten on the book)



ARB  
DS

In 1924, near Yekaterinoslav, Ukraine (now Dnipropetrovsk) the 3 daughters of a certain Captain Andriychuk simply vanished.



Captain Andriychuk was of Russian descent and very little is known about him, except that he travelled a lot.

A farmer that lived near Captain Andriychuk's house said that he saw the Captain's daughters walking towards the woods maybe 2 hours before sunrise.

Intrigued, he followed them at a distance. After walking for 30 minutes he described seeing "purple and red lights and a mist" through the trees.

He got closer and saw the 3 girls entering what he called "a floating bright windmill-like plane"... he also reported seeing 5 creatures as small as the children but with a "much older face".

According to him the "windmill" then flew very slowly "into the stars" until he could not tell them apart.



ARB  
DS

According to the farmer, he ran to Captain Andriychuk's house to warn him about the event.



This photo supposedly shows the farmer's house

Upon arriving he knocked on the door but nobody answered...

He then entered the house and found the Captain and his wife dead on their bed...their faces "were peaceful", as if they had died during their sleep.

All their animals (3 dogs, 1 horse and 2 goats) were dead as well.

On the kitchen table there was a letter or note (not signed) with the handwriting that matched Sofiya, one of the daughters.

It said:  
"We are going to the school in the moon, with our friends..."



supposed photo of Sofiya (not confirmed)



ARB  
DS

TO:

SMERSH Agents Department IV-A1/12

It is your duty to thoroughly investigate all events regarding any reports of visitations or incidents concerning creatures from other planets as well as with non-terrestrial creatures that dwell on our planet at the present or future time.

It is your duty to immediately present to your Superior in charge (KL-44) any material evidence gathered during your investigations.

It is your duty to keep absolute secrecy and concealment regarding your findings and conclusions during your investigations except from your Superior in charge (KL-44).

It is your duty to immediately destroy this book in case your physical being or personal safety is threatened.

The loss of this book while in your possession will result in serious consequences for your 2 SMERSH companion Agents as well as for your immediate relatives.

Make use of your extensive training and love for our great Union.



Chief Marshal Konstantin A. Vershinin

1947



ARB  
DS



This book of alien races is both an instructions manual and a source of information to be used now and in the future until the day it will be needed no more. Learn from it and add to it.

When with Humans:

- 1- Investigate events
- 2- Interrogate witnesses
- 3- Gather physical evidence

When with aliens:

- 1- Engage with them
- 2- Follow them
- 3- Learn from them



YOU ARE FORBIDDEN OF:

SHOWING THIS BOOK TO ANYONE, TALKING ABOUT THE BOOK TO ANYONE, TALKING ABOUT OR REVEALING YOUR INVESTIGATIVE ACTIVITIES TO ANYONE, DRINKING ALCOHOL ON AND OFF DUTY, CONSUMING DRUGS ON AND OFF DUTY, HELPING ALIEN RACES NO MATTER THE SITUATION OR REQUEST, CHOOSING "SIDES" WHEN PHYSICALLY AMONGST DIFFERENT ALIEN RACES OR DURING INVESTIGATIONS, AND OF ENGAGING IN SEXUAL ACTIVITIES WITH ANY MEMBERS OF ANY ALIEN RACE.



ARB  
DS

# THE ALIEN RACES



© 2000-2001 ARB DS. All rights reserved. ARB DS is a registered trademark.



ARB  
DS



ALLGRUULK  
(aka "the builders")

They come from constellation Sculptor.

They derive from an ancient race of reptilians that has gone extinct.

They are specialist at building ships and other devices needed for deep space travelling.

They are also space-travellers themselves, searching for new raw materials.

They can live up to 230 years.

Last seen near Tokyo (Japan) in 2005.

THE SCULPTOR SCULPTOR SCULPTOR SCULPTOR



ARB  
DS

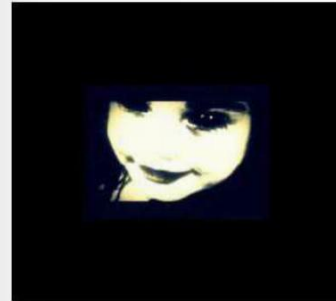

KIILY-TOKURT

They come from constellation Vela, near the star Suhail Al Muhlif.

They grow up to 2 meters high (6 ' ) and live up to 200 years.

They can shape-shift and are very hard to detect.

When they shape-shift the only thing they cannot change is the size and colour of their eyes.

They are one of the oldest known races.

They do abduct humans.

Last seen on earth in July of 2008.

THE VELA VELA VELA VELA VELA VELA





ARB  
DS



PLEYADIYANS

They come from solar systems surrounding the Pleyadiyes stars, more precisely from the planet Erra near the star Taygeta.

They are associated with spiritual growth.  
They can grow up to 2.5 meters (8').

They practice "sex cultivation", the distinct difference between their sexual expressions and their sensual emotions.  
Their ships are known as "beamships".  
Although regularly visiting Earth, they have remained mostly "silent" since 10.000 BC.

They are one of the oldest known races.  
They continue to develop the necessary mental skills to eventually reach their goal: an even higher "spiritual state".



ARB  
DS

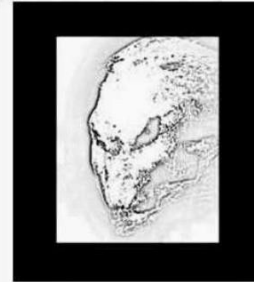

KYLLIMIR-AUK

They come from constellation Volans.

The sightings of this race on Earth are rare and they are considered as "a mystery race".

It is said that they were forbidden to visit Earth around the year 1.000 BC, but they did not stop visiting Earth completely... this because of their allies: the race Maitre.

Last seen on Earth: December of 1989.



ARB  
DS



KURS  
(aka "Gods of Lands")

Believed to be related to the race Anunnaki.  
They come from the planet Dillimuns.  
They are the race "behind" the story of Enlil and Ninlil

They were directly involved on the development of the Human race during our early stages.

After centuries away from Earth they have recently returned.  
Their own leader is amongst the most recent visitors.  
They will now stay on Earth permanently...they will have an important role in the years to come.

They spend time immersed in a precious gold-like liquid that presumably extends their life span.



ARB  
DS

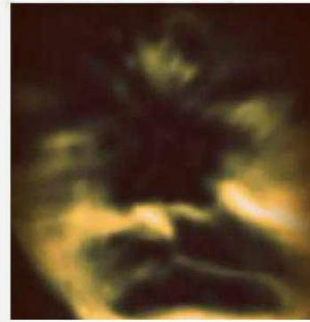

HAV-HANNUAE-KONDRAS

They come from galaxy Sextans Dwarf SPH.

First visited Earth in 934 AD in the area that we now know as Romania.

They often abduct and kill humans...they also drain and drink the blood of Humans as well as the blood of animals.

They are responsible for the myth of vampires.

Several Human governments know and accept their actions.

The Human bodies that they "use" are never returned.

Last sighting: Scotland, in 1996.



ARB  
DS



MAZAREK

They come from constellation Camelopardalis.

From the 1300's to the early 1900's (our calendar) they were not allowed to leave their planet by other alien races.

They are a very violent and "predatory" race.

They are known to be allies of the race Maitre.

They grow up to 1.6 meters (5').

Last seen on Earth: August of 2001.

© 2001 ARB DS. All rights reserved. 12



ARB  
DS



AL-GRUUALIX

They come from constellation Cetus, near Deneb Kaitos Shemali.

Although they are often confused with reptilian races, they do not share anything with them except their appearance.

Their height is around 2 meters (6') and they can live up to 350 years.

This is one of 21 races that are known to have more than 2 genders (sexes).

This race has 8 different genders and all of them can reproduce with each other.

The purpose for their visits to Earth is unknown.

Last sighting was near Lima (Peru) in December of 2004.

© 2001 ARB DS. All rights reserved. 13



ARB  
DS



MOOVIANTHAN-KAYPHIK  
(aka "shinning ones")

They come from constellation Vulpecula.

They have met with (at least) 2 USA Presidents as well as with USSR and (now) Russian leaders and some high-ranking officials.

They supply limited amounts of their technology to humans in exchange for the "freedom" to conduct abductions. They do not involve other alien races in this process.

They had a big role in Siberian and Tibetan culture. They still have bases in those areas hidden in the north-face of mountains.

They have colonized over 40 planets outside our solar system... so far !



ARB  
DS



RAK

Of the 58 races described here, this is the race that least visited Earth (that we know of so far)...only 5 times.

They visited the area we know as the middle-east and that created the belief in the "Jinn" (or "genies") in Islamic mythology.

According to some Muslims scholars they inhabit an unseen world in a dimension beyond the existing dimensions of our universe.

According to reports from other alien races, they stopped visiting Earth because their immune system could not cope with Earth's fauna and flora.

Last recorded visit: 712 AD.





ARB  
DS



"THE INVISIBLES"  
(no image)

This race is known to have been "seen" near high-security areas.

They are almost completely invisible to the naked eye.

Both the USA and Russian military have developed technology that allows them to track them down on radar (just the ships).

3 things are known about this race:

- 1- they leave a sour smell when they are near.
- 2- when they are near windows you can "see" their reflection as a "smudged-like" figure (have been caught on CCTV footage)
- 3- when many dogs (or only 1) start barking with no apparent reason, it is possible that they are nearby (or Reptoids/Reptilians)

They come from constellation Mensa .  
Purpose of presence: unknown



ARB  
DS



ALLMAHULUK-STRAT-163

They were forced to leave Earth after losing a battle against Reptoids in ancient India (date unknown), which they had been visiting for around 200 years.

They have resumed their visits to Earth in 1948.

Technologically this is a very advanced race.

Their ships are often invisible (to radar and the Human eye) and they wear some sort of clothing that makes them invisible as well.

Supposedly they come from Jupiter or from one of its moons.

Last sighting: Portugal, May 2005.



ARB  
DS



AINANNA  
(no image)

The members of this race are the cause why Humans coined the term "Martians".

They come from constellation Gemini.

They have had permanent bases on Mars for thousands of years, where they mine some sort of a gold-like material.



First recorded visit to Earth: 1235 BC in Japan.

Last sighting: Madagascar, 2003.



ARB  
DS



INDUGUTK  
(aka "Tall white")

This race has several bases on and in the Moon, where they mine (unknown material).

They use "slaves" to do most of their work...these "slaves" are extremely well taken care of, and the Indugutk see them as "indispensable".

Their operations on and in the Moon are very secretive.

They are in almost permanent contact with High-ranking officials from the USA, China and Russia Fed. governments.

They have the ability to shape-shift into an almost perfect Human form.

They are also known as "Men in Black", as they use special dark suits (to protect their skin) when in Human-shape while conducting special operations on Earth.



KILLIMAT-ARR  
(aka K-ARR)

They come from constellation Crux, near Gacrux.

It is a very hard race to track down or spot.

Both the USA and the Russian military have developed a special camera and radar system that allows to spot them when they are on Earth.

But even then, they have only been sighted 8 times.

The purpose of their presence is unknown.

When they are sighted it is usually in the area known as the Bermuda Triangle.



2017  
(no image)

They have only contacted Humans one time: in the USSR in 1935.

According to reports they spoke some kind of Slavic dialect. They left a written message with about 10 sentences.

They come from galaxy UDFJ-39546284. Estimated distance from Earth (our standard) is 13.2 billion light years.

They travel by using what other alien races call "worm-hole", which allows them to "bend" space.

(note from myself and Petro)

On the original ARB (our copy/edition), 9 of the sentences left by this race are "blacked-out"...the only one that is not is this one:

"2017-2022"

According to reports they were tall, had blonde long hair and "smelled like flowers"



ARB  
DS



EL-MANOUK

They come from constellation Grus, near the star Alnair.

They are one of the most peaceful races.

They co-created the alliance of the 5 races ("Council of the Five"), but are not part of it.

The "Council of the Five" are a group of 5 alien races that protect Humans against less peaceful races.

They "coined" the sentence: "5 universes, 2500 species, 1 race"

The Council is supposed to meet on Earth during the last 10 days of August of 2013, the reason being the fact that Earth has been receiving "too many" visits from new races in the past 500 years.

Last sighting on Earth: near the Sea of Cortez, September 2002.



ARB  
DS



JIGHANTIK

Maintains sporadic contacts with 3 Earth governments, but not the most powerful ones (not USA, Russia or China).

Considered to have a violent nature by other races.

They have been visiting Earth for 3.000 years.

They come from constellation Horologium and are known to have as allies the race Maitre.

Last sighting: near Houston, USA, February 1 of 2003





ARB  
DS



JEFOK

They come from constellation Indus.

They are known by other races as "peace-makers".

They are very advanced technologically.

Their first sighting on Earth dates back to 1500 BC.

They met with JFK 3 weeks before he was killed.

They have also (around the same time) met with other Human world leaders.

They have not been seen on Earth since JFK's death.

In 1965 they gave a message to the Human leaders that ran countries with nuclear capability (content unknown).



ARB  
DS



DORSAY

They grow to a maximum height of 0.5 meters (1.6').

They have visited Earth at least 250 times.

They come from Cassiopeia, where they have 2 home-planets.

They eat other alien races as well as humans.

Their race is at least 4 billion years old and they have been in a constant state-of-war with another alien species for 2 billion years.

Last sighting on Earth: November 2001, Italian Alps.



ARB  
DS

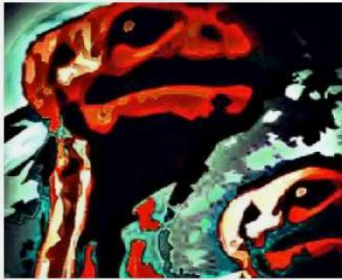

MAGELL

Known to be a very peaceful race.

They have 2 permanent bases somewhere in South America.

They are 100% nocturnal, do not interact with Humans and are described by other alien races as "shy".

They harvest insects and rodents by the many thousands on a monthly basis...reason: unknown.

At least 3 of them have been under Brazilian military custody for the past 12 years.

Last sighting: near Oaxaca, Mexico, in 2003

They are visited by their own kind (race) every 20 years...the next visit should be around 2016.



ARB  
DS



AKART

They come from constellation Sextans.

One of their ships crashed outside of Varginha (Brazil) in 1996.

2 of its occupants are under USA custody, after having paid billions of dollars to the Brazilian government.

They have the fastest ships of any known alien race.

Last sighting: February 2002, near Varginha (Brazil)...again !



MAITRE

They have 2 home-planets in constellation Megopel.

They have the same average height as Humans and are considered by many alien races as "parasites".  
Visited Earth for the first time during the pre-historic period (date unknown).

Abduction of Humans is carried out openly.  
They have the goal of colonizing Earth...that has not happened because of protection from other alien races, such as the one's in the "Council of the 5".

They are hermaphrodites and their life span is 120 years.  
They have colonized at least 26 planets.  
They have abducted at least 5.000 Humans (males).

They have visited Earth at least 200 times.

Last sighting: September 2006 near Nome, Alaska, USA.

ARB  
DS



DRIES

Their height is around 2.5 meters (8')  
They have a very complex structure of their skull.  
Visited Earth at least 20 times.  
They carry out Human abductions which they use for Human reproduction.

They have abducted at least 520 Humans (males and females).  
They come from the "third" star in constellation Cetus.  
They have 2 home-planets and have colonized at least 40 planets with the help of "slaves". 10 of those planets were taken with the use of force. They work together with 3 other races. They mostly eat animal protein derived products.  
According to alien reports, they are not "mentally/spiritually" prepared to interact with most other races.

Their 2 home-planets chemical composition is similar to Earth.

They are supposed to "reveal" themselves to Humans in an open manner in 2022.

ARB  
DS



ARB  
DS



LANG

Small species growing only up to 70 centimeters (2').

They come from the "sixth star" in constellation Coma Berenices.

They have 3 home-planets (maybe 4) and have colonized at least 10.

They were one the first races to visit Earth.

They were the race that started the "stories" about Fairies.

2 alien races claim that they have abducted over 10 million Humans throughout History (that number is highly disputed by 2 other races...they state that the number is much lower...and 1 race even made a statement to a Russian President saying that the race Lang has never abducted any Human).

Last sighting: New Zealand, in 2006...a group of 20 members.



ARB  
DS



SMAD  
(no image)

They come from Planet Svokk, constellation Battteray.

Their ships have a conical shape.

They resemble Humans in appearance.

According to 1 alien race they only have 6 ships left.

They colonized 20 planets, 18 of them were inhabited.

They first visited Earth 2.500 years ago and are very interested in our religious beliefs.

They are a race in decline ("weakening", according to other alien races.





ARB  
DS



TENGRI-TENGRI

They come from planet Tengri (galactic sector 56, star system F-1342).

They live underground and have a population of 10 million.

First visit to Earth: 10.000 years ago.

They do not need an atmosphere or water to survive.

They have 1 ship that can accomodate 5 million of their kind.

They have had contact with Human governments throughout History.

Last known sighting: near Buenos Aires, Argentina, in 2003.



ARB  
DS



GRAYSLI

Their height averages the same as that of Humans and they are covered in a soft silky hair.

They have 2 home-planets in the Virgo star system.

They have visited Earth at least 12 times.

Their first visit happened during the era (dinasties) of Egypt's Pharaohs, around 3.000 years ago.

They spent 10 UN-interrupted years there during that time.

The Djoser pyramid was built in their honour.

They have been keeping a close look at Human's development for the past 200 years, knowing that some powerful humans can (and are) be misled by some alien races (disguised as "humans").

Only 6 of them travel each time in their ships.

Last sightings: July-2002 and February-2004



ARB  
DS



ANUNAKENE  
(aka Anunnaki)

They come from planet Nibirue (aka Nibiru).  
 Their planet is part of the same solar system as Earth, but with a much longer orbit...it comes closer to the Sun every 4,000 years, and not every 3,500 years as commonly accepted.  
 They resemble Humans but are higher (2.5 meters/8') and more muscular.  
 When they first visited Earth there were already other races established here...some malevolent and with supernatural powers. The Anunakene defeated them and became the most powerful race on Earth.  
 They genetically engineered the most intelligent non-alien beings on Earth (us...at the time not much more than smart primates) in order to have a race of slaves at their disposal.  
 At the time Samael and Lilith were the Anunakene King and Queen. They were not aware of the presence of Reptilians on Earth.  
 They only cooperate with one other race: the Zeta Reticulai. Not to be confused with the Solipsi Rai (aka "grays").  
 Eventually they left Earth (unknown reasons) but before they left they created a sub-species of the Zeta...this species eventually became rulers of Egypt (Pharaohs) until the Reptilians infiltrated them (as Temple Priests) and ended their Reign.  
 They gave birth to the legends about "giants".



A  
I



ANUNAKENE  
(aka Anunnaki)

They will return one day as promised by themselves, however the date of their return is still a mystery.

They do know all that is happening on Earth as well as in other planets where they had influence (and/or still have).

The proximity of planet Nibirue (aka Nibiru) does cause cosmic instability and weather-related repercussions in all planets of our solar system, but does not cause the amount of destruction that it is usually accepted and believed.

How far they are it is still a mystery.



ARB  
DS



AFIM

They come from constellation Lyra.  
They call themselves "Afim Spiantsy" because of a war that they fought against a race called "Spiantsy"...the "Spiantsy" race had 12 times more members and 35 times more ships and resources than the "Afim"...but the "Afim" won in the end...  
So they added the "Spiantsy" name to their own race-name, as a "warning" to other races...  
They are smaller than Humans in stature and their skin is covered with blue spots, darker for males and lighter in females.  
Their planet is called Crimea Ai-Petri.  
Technologically they are extremely developed..they can travel from their planet to Earth in 20 earth-minutes.  
They do not need oxygen, they do have an atmosphere but it is composed mainly of an hydrogen-mix environment.  
They have colonized 10 planets in a non-violent way.  
When they are close to humans they can become invisible, but humans when around them will feel a certain amount of unexplained anxiety.  
Their ships are small and spherical in shape. One of the reasons they visit us is to study what they call "Human Deviation", in order to determine the development of the Human race.



ARB  
DS



SOLIPSI RAI

Peaceful and harmonious race.

They 1 main leader and his name is Ymartyyn.

Their civilization is 2 billion years old...once they were at the same level of development as ourselves.

They have no colonies...they are completely focused on the development of other planets and races.

They come from constellation Cygnus.

They do have one powerful weapon that keeps some neighbouring violent races away...and others that may try to invade them...at one time race Maitre lost 5 ships because of it.

They said that the Human race, in the next few thousands of years, still has 645 options left to save ourselves, our planet and to guarantee a future for our race...but it will all depend on our ability to travel through space.

They are Solipsi Rai, but we call them..."grays" !



ARB  
DS

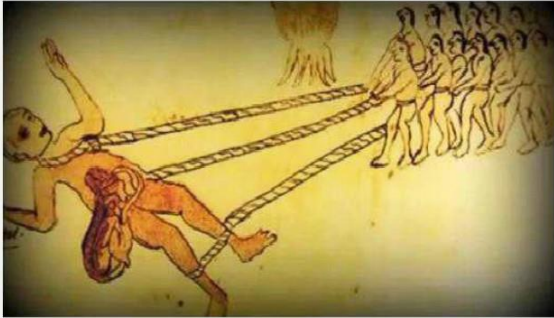

PUXHITY  
(no image)

This race was very influential in some South and Central American cultures.

At one time they had over 2,000 members living amongst Humans in those regions...until one day when most of them left, leaving behind only 25 of their own...Humans then killed them.

They have not returned to Earth since that "incident".

They were known to be very tall...some reports from one alien race say that some of them were as tall as 4 meters high (13').

The reasons why the local Humans killed the 25 Puxhity's is unknown.



AR  
D:



X5-TYKUT

This race was created by the race Maitre in order to be used as slaves...and that is still what they serve for.

They are often sent by the Maitre to security-sensitive regions, working as messengers and also to conduct abductions.

They can live forever as they are not organic...however the raw materials that the Maitre need to "build" one are very rare. So, there are not many of them (estimation: less then 300).

They are able to use "rational thinking" as well as flying ships and many other tasks.

Last seen on Earth in July-1997, near Brisbane, Australia.



ARB  
DS



TANZANY

They come from constellation Perseus, near the star Gorgonea Secunda.

They have caused thousands (maybe millions) of deaths on Earth and other planets as one of their interests (or area of "study") is how other races react to tragedies and cataclysms.

Technologically they are extremely advanced.

One alien race reported that they (the Tanzany) caused both the crashing of the Hindenburg as well as the sinking of the Titanic.

They can live up to 500 years and are around 1.7 meters tall (5').

They are avoided by other alien races.

Last sighting: January 1999 in New York state.



ARB  
DS



AIRK

They come from constellation Ophiuchus, near Yed Prior.

Considered by other races as peaceful.

The purpose of their visits is unknown...they never stay long on Earth and do not interact with Humans or other aliens here.

They mostly use Earth as a "stop" (to quickly gather something they may need) before they leave to their real destination.

They are mostly nocturnal.

Their ships emit a bright-orange light and are (most of them, not all) octagonal in shape.

Last spotted near London (England) in May 2003.





VINNYTVARY

They come from constellation Pavo.

They are a very respected and peaceful race presumably with mystical powers.

They have been coming to Earth at least since 1.000 AD.

They do not carry out abductions and do not interact with Humans.

They can live up to 2.000 years.

Their height is similar to that of a normal Human.

They are vegetarians.

Last sighting: near Odessa, Ukraine in July of 1995.

ARB  
DS



STROM

They come from constellation Ursa Minor.

Stroms are invertebrates and coelenterates.  
Their average height is 2 meters (6.5').

Vegetation is of great importance to their culture...and the main reason for their visits to Earth.

They have been on Earth at least 200 times.  
They act with extreme caution and are rarely seen by humans.

First visited Earth at the end of the last big Ice Age.  
They have 20 colonies in the Via Lactea galaxy.

Their ships have the shape of an octagon.

Last sighting: October 1976 in Oregon, USA.

ARB  
DS



KALENIA

- They come from constellation Aquila, star Tarazed.
- They have colonized 3 planets and have a life span of 150 years.
- They are often sighted in northern Africa and the Sahara region.
- First visited Earth around 300 BC.
- They do not conduct abductions.
- Main interest about Earth: minerals.
- Last sighted in 2003 near a volcano in Iceland.

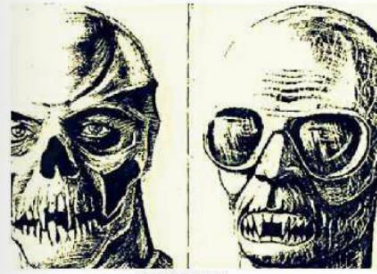

MYTHILAE

- Once related to the Reptoid species, they are not, however, Reptilians.
- They come from constellation Serpens, star Alya.
- First visit to Earth was only in June 13, 1965.
- They do not represent any threat to Humans.
- Often seen around Antarctica.
- The reason for their visits is unknown.
- Last sighting: Antarctica, May 1, 1997.



ARB  
DS



REPTILIANS

The most known and feared of the Reptoid species (there are at least 3).

They have been permanently on Earth for over 15.000 years (confirmed) but the belief is that they may have been here (permanently or on-and-off) for millions of years.

They come from constellation Draco.

They have a presence in thousands of planets and have at least colonized 500 by means of "infiltration" within the leadership of each planet...

Some (not all) of their members have the power to shape-shift as well as telepathic abilities.

On Earth they did not need to infiltrate Human leadership all the time as they often lived side-by-side with Humans (most of them unaware) and "lived" our evolution (all aspects of it).



ARB  
DS

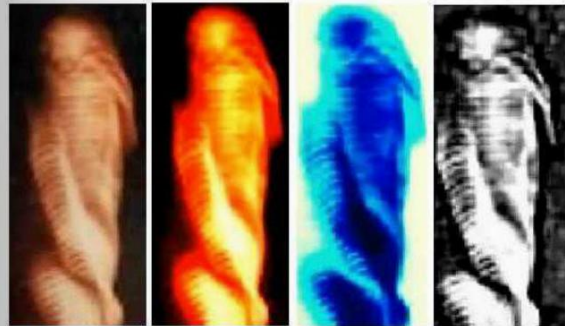

REPTILIANS

They are considered one of the most technologically advanced species, but they prefer to work in the "shadows", using that as an advantage for their progress or plans/agenda.

They can travel inter-dimensionally (most races can't) and some of their high-ranking members also have the power to become invisible...to have that power a reptilian must first be accepted in what they call "The Draco", an elite group of Reptilians.

The Reptilians from "The Draco" are infiltrated (or even were co-founders) of the Illuminati.

They have 3 main bases on Earth: near the Bermuda Triangle, somewhere off the coast of Denmark and off the coast of New Zealand.

Some say that they will never leave...at least on their own !



ARB  
DS



ALCOHBATA

Presumably they have over 5.000 ships and have colonized over 100 planets on their own.

Considered by other aliens as one of the "parasite" races.

Abduction of Humans are frequent and on-going...  
Purpose of Human abductions: unknown.

They do not like to interact with other alien races.

They come from constellation Perseus and are extremely aggressive.

Suspected to have been involved in several airplane crashes, such as flight 007 over the USSR in 1983. The USSR leadership took the blame for that crash...

Last seen: September 2001 in Canada.



ARB  
DS

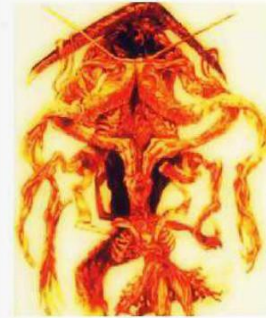

NEGUMAK  
(aka Gnomopo)

First known visit to Earth happened only in 1989.

They abduct Humans and exercise control over the minds of their captives, which they use for their own benefit after the captives release. Reason: unknown.

This race was the "inspiration" for the alien race in the movie "Independence Day". (note of Petro and me: the ARB states the same thing about another race)

They are one of the oldest races.

They are one of the races that most Human governments fear when considering the future of Humans.



ARB  
DS



ZETA RETICULAI  
(aka Shamtbhala)

Often confused (because of their appearance) with the races Maitre and Solipsi Rai (the "grays").

They come from constellation Nets.

They are allies of the Anunnaki and cooperate with them in different planets...they are the representants of the Anunnaki on Earth and send them information about Humans and this planet at least 25 times per year.

The Anunnaki created a sub-species of the Zeta with the purpose of making them look more Human-like...but leaving enough physical differences for Humans to distinguished them.

They became some of the Pharaohs of Egypt.



ARB  
DS



ZETA RETICULAI  
(aka Shamtbhala)

The most well known was Akhenaten, who was removed from power by Reptilians...they infiltrated themselves in the Court as Temple Priests.

First reports of Zeta's on Earth go back to 4.000 AD, but that number is most likely much higher.

They were the first hybrids to be engineered by the Anunake (Anunnaki).

The Zeta sub-species still exists on Earth and still (at least 30%) present the same physical differences created in them.

The sexual organs of the sub-species are in every aspect the same as that of Humans.





ARB  
DS



ZETA RETICULAI  
(aka Shambhala)

The Zeta's still exist on Earth in both forms...the "original" and the hybrid sub-species.

Their location on Earth is...unknown !



Zeta Reticulai



Zeta hybrid sub-species



ARB  
DS

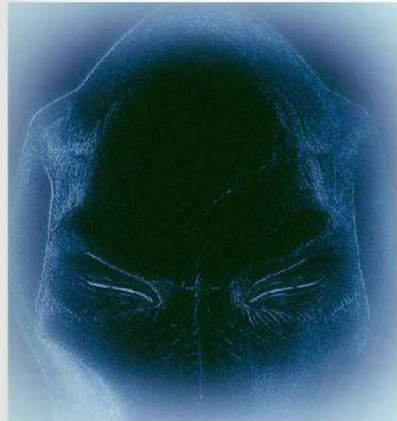

TARICE  
(no image)

Their origin is unknown.

They are often seen near (or flying by) volcanoes. (Identified due to the exquisite nature of their ships)

They have never contacted Humans and there are no reports of violence or abductions.

Even though they are discreet their presence on Earth is frequent and they do not try to hide from view. There are several contradictory reports about their appearance.

Last sighted: Off the coast of Norway, in 2000.



ARB  
DS



PURITAV-ILLUMUJ  
(aka Nosyv-7)

Their origin is unknown.

They are often sighted in the northwest of the USA (specially in the Oregon area).

They have a special interest about Earth's oceans and are known to have underwater ships (aka USO's).

In the 1980's and the 1990's they almost crashed a few times against US Navy ships while the americans were testing new sonar and radar systems.

They are peaceful and mostly nocturnal.

Last sighted in the year 2000 near San Francisco, USA.



ARB  
DS



X-1Z  
(aka "X")  
(no image)

Only sighted 2 times on Earth.

According to reports from other races they are able to shape-shift as many as 4 times in 10 seconds.

Their origin is unknown.

They conduct Human abductions and perform medical experiments on the subjects.

They have been visiting Earth since the mid-1500's.

The only 2 confirmed sightings happened near Elazig, Turkey.



CARAVELDI

Known to be (at times) extremely dangerous to Humans as well as to other alien races.

They come from constellation Chamaeleon.

They have been permanently involved in conflicts with a few other races for over 500 (Earth) years.

They are rarely seen on Earth.

They live up to 150 years old.

Reportedly they are 3 meters tall (9') and have 4 arms.

Last sighting was near New Orleans, USA, in 1976.

ARB  
DS



ELFFAF

They come from constellation Bootes, near Asellus Primus.

They also resemble the "grays" but are not "related".

This race has 4 different genders and they are known to be benevolent.

The purpose of their visits is unknown, but they seem to have a special interest on raw materials/minerals (?) as they have been often sighted near old mines.

Last sighting: San Isidro de El General, Costa Rica, in 2005.

AR  
D





ARB  
DS

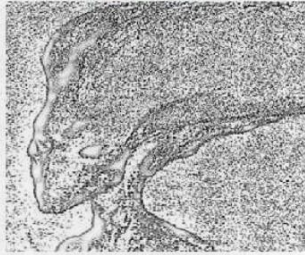

MATRAX

Despite their appearance (installs fear in Humans when sighted) this race is not known to be aggressive.

They can live up to 400 years.

They come from constellation Delphinus, near Sualocin.

They have been visiting Earth for at least 4.000 years, but were sighted quite often during the 19th century.

They served as inspiration for the alien race in the movie "Independence Day".  
(note of Petro and me: this the other -second- mention about a race being used as inspiration for that same movie)

Last sighting happened near Marseille, France, in 1996.



ARB  
DS



TISAR-3

Their origin is unknown but there are reports stating that it takes them near 2 Earth years to get to this planet.  
They are the survivors of an extinct Reptoid race and do not possess the same level of technology or knowledge as other races visiting Earth. They do have some Human characteristics, such as skin.

In 1977 or 1978, near Siena (Italy), 2 of their species were captured after landing behind a church in ruins...3 days later they were transferred to a USA air base still in Italy and finally taken to an undisclosed location where, supposedly, they still remain...contacts have mentioned somewhere in the South Pacific or in another USA base near Japan.

The USSR APIS/3 was able to get a hold of 1 video recording of this species.

Last sighting: January 3 2001, near Victoria, Canada.



ARB  
DS



ELLINA  
(aka "Elves")

Supposedly this is the race that started the myth of Elves (Elf). They are sighted often in the Germanic countries, deep in the forests.

They are not known to be lethal to Humans, however they are known as being "pranksters"...it seems that they enjoy scaring Humans when these get too close.

It has been reported that they have lured Humans away from their cars in order to steal their possessions...once the Humans are far away from their vehicles (and they already have stolen what they wanted), they frighten them which makes the Humans leave the location.

Last sighting: Near Munique, Germany in December 2004.



ARB  
DS

# THE COUNCIL OF 5







Reptilian shape-shifting in progress (2)

ARB  
DS



ARB  
DS



### Раса Мэтра

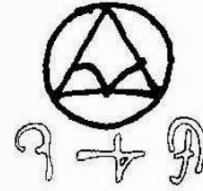

The Maitre have been involved in several tragedies throughout Human History...

Some of the worst plagues were inflicted by them with the knowledge and agreement of the Reptilians, who want the Human population to never go over 8 billion.



The Reptilians have abducted female Humans for thousands of years...most of their hybrid offspring are sent away to other planets that they have colonized...some stay on Earth where they become powerful members infiltrated in society.



ARB  
DS

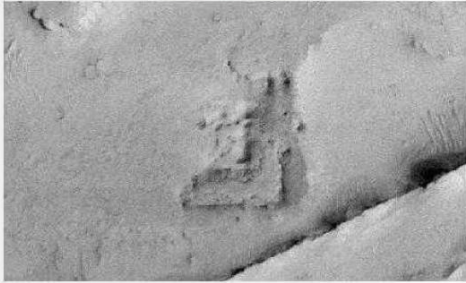

Mars and the Moon have been over mined and explored for the past 33.000 years...the races that do it are going deeper and deeper inside the planet to reach the raw materials they want. Abandoned surface structures can be seen everywhere.



All Human religions have been created by alien races that want to keep Humans divided and the TRUTH about CREATION in secret. They roam the corridors of religious power as members of pseudo-religious-spiritual-Human organizations such as The Masons (most members of The Masons are clueless about the true intentions of a few)



ARB  
DS

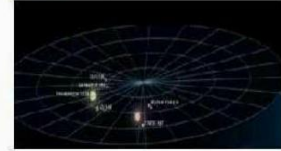
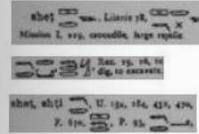

Since the formation of the USSR its leaders were extremely interested about all the information they could get on aliens. They knew of their existence and visits and wanted to gain their knowledge, little knowing that the death of Russia's Czar Nicholas II had been planned by aliens and that their own circles of power had already been infiltrated.

Several secret missions were deployed by Stalin to South and Central America after two Generals found a book that belonged to Czar Nicholas II's wife (Czarina Alexandra) and Grigori Rasputin, that had a map showing the location of alien bases.

That map was later used in the school system, minus the bases locations.





ARB  
DS



Very little is known about the five alien races that are part of the "Council of 5".

The races that are part of this Council (previously known as the "Council of 9") have been protecting Earth and the Humans for as long as there are (alien) records of it.

Some say that they have been protecting the planet even before Humans existed...for millions of years !

An alien race reported that the "Council of 5" last met on Earth in 1944.

(note of Petro and myself: we found a hand-written note on the ARB dated July-2005 stating that the "Council of 5" is going to meet on Earth during the last 10 days of august of 2013. The same note also mentioned the fact that the presence and arrival of those 5 races could cause cosmic events that can affect Earth's atmosphere. And it also said that Humans would be seeing an increase of alien ships activity during that period)



ARB  
DS

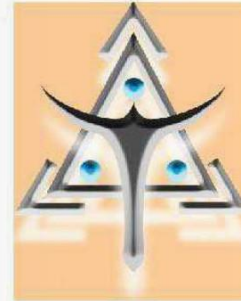

(continuation of note: the note also states that the meeting of the council is to discuss possible threats to Earth and Humans as well as the fact that so many "new" alien races have been visiting Earth "lately"...by "lately" the note states that that means -to the 5- for the past 500 years)

-//-

According to several alien races the "Council of 5" (at the time "Council of 9") has monitored Human evolution since primordial times, since Humans were only a 1 cell marine organism and throughout all natural evolution, when Humans became primate-like creatures and beyond (after the Anunakene, aka Anunnaki, interference...).

According to those same alien races all evolutionary sequences in all planets have a beginning and an end (with the exception of minor details due mostly to radical weather changes). After the Anunakene tampered with the DNA of "primates" and created Humans, the "Council of 5" decided to not only monitor but also to protect us, as they realized that one day Humans would be able to join other alien races in development and enlightenment.



ARB  
DS



The Philadelphia Experiment of 1943 did happen and it was successful after the 3rd attempt...further attempts failed.

Contrary to belief the experiment resulted from Albert Einstein's discovery of a manuscript (along with 1 metallic object) found in a cave system and brought to Spain by Columbus on his last voyage.



ARB  
DS

The manuscript found by Columbus contained extremely technologically advanced schematic drawings and information and it was used to develop the unified field theory by Einstein, where he described mathematically and physically the interrelated nature of the forces that comprise electromagnetic radiation and gravity. Einstein had Illuminati connections.







ARB  
DS



THE "COUNCIL OF 5" IS COMPOSED OF THE FOLLOWING RACES:



ORELA



ARB  
DS



THE "COUNCIL OF 5" IS COMPOSED OF THE FOLLOWING RACES:



EGAROT





ARB  
DS

In 1933, near Vergiate, Italy, an alien ship belonging to the race KALENIA crashed killing all its occupants. Inside many ancient Italian artifacts were found. (and alien ones) Benito Mussolini created a secret group to look at that incident and any other future ones related to alien races. That group still exists and its called GIO-1. All the artifacts found on the wreck were put in a museum and passed as if found at an archeological excavation. In 1950 another ship crashed at the same location.

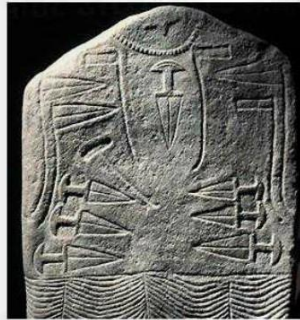
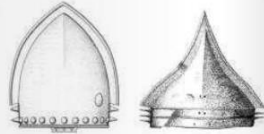

ARB  
DS



During the early 1950's USA President D. Eisenhower and British PM Winston Churchill met several times to discuss the best ways to keep the alien presence on Earth away from the general public and from prying eyes.

Together they created a top secret task-force called "SILK". This task-force was so secretive that its leader was an Air Force General from english descent that belonged to the military of Uruguay.

Side by side with this General worked 2 USA and 2 English Secret Services agents.

They were not allowed to write anything they investigated. All events and investigative progress were only reported face-to-face to both Churchill and/or Eisenhower.



THE "COUNCIL OF 5" IS COMPOSED OF THE FOLLOWING RACES:

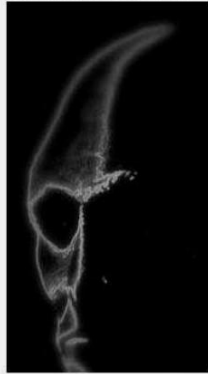

GINVO

ARB  
DS



THE "COUNCIL OF 5" IS COMPOSED OF THE FOLLOWING RACES:



REDAN

AR  
D



ARB  
DS

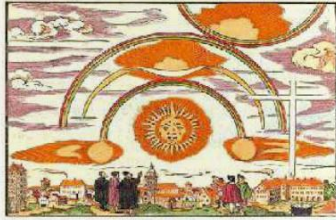

From 700 AD to the 19th century AD over 50 battles between alien races were fought on Earth's skies and witnessed by thousands of people. Many artists painted and carved these events, but the Catholic church searched, found and destroyed most of them. In the 20th century only less than 10 are available.

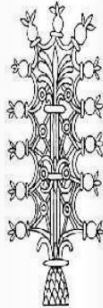

18th century



ARB  
DS

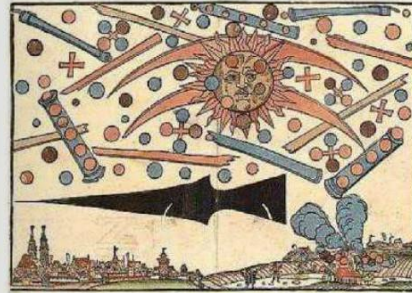

"As long as there are stars, there will be war"  
Race Maitre





ARB  
DS



August 1608: from Marseille and Nice (France) all the way to Genova (Italy) alien ships stop by the sea shore and crew members work on the vehicles openly for everyone to see.

This painting shows 3 alien ships in Nice.

(NOTE: this is the original illustration. In the 1970's a magazine purposely improved its quality in order to make it look contemporary and be able to debunk the event)

Real witness of the event wrote the next day:

"The inhabitants saw three strange luminous vessels which evolved at high speed above the city. The three machines stopped near the fortress and went down above the waters where they caused the water to boil and emit a red-orange vapor. To the great stupor of the numerous witnesses, two humanoïd beings with large heads and large luminous eyes, dressed in a red suit with silver scales, connected to the flying machine by tubes, engaged themselves in several hours of strange work."



ARB  
DS

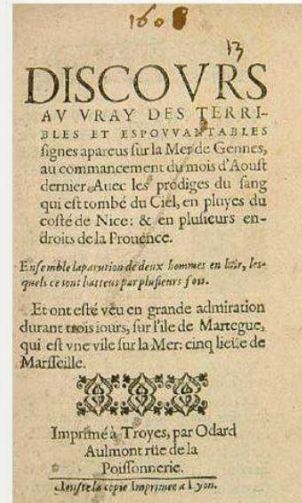

This is the original report from the alien event of August-1608 in Marseille, Nice and Genova.

During your investigations in our territories or abroad you will often find misleading and/or falsified information concerning sightings and/or alien contact...this misleading and/or falsified information will concern mainly dates, places, witnesses, time and weather conditions at the time of the event.

This pattern of deception is common and has been practiced for centuries either by religious organizations, secret sects, privately owned media and infiltrated Human governments.



THE "COUNCIL OF 5" IS COMPOSED OF THE FOLLOWING RACES:



EMETHER.



It is generally agreed that the EMETHER is the most important race not only of the Council but also amongst all known races ! They are related to the Solipsi Rai, but much older and advanced in all levels. They were one of the Founder-Races of the Council. They met with USA President D. Eisenhower in 3 different occasions...they also met with 2 High-Ranking USSR leaders in 3 different occasions...and they tried (they do not "force" anything upon Humans) to meet with USA President R.Nixon but he refused claiming that it would be too dangerous as they could maybe read his mind and find out about delicate national security secrets concerning the relations with the USSR.





ARB  
DS

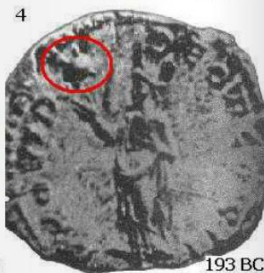

Images 1, 2 and 3 show commemorative coins (no transaction value) from 3 different families. They depict 3 ships from 2 alien races. A western European magazine tried to debunk these by stating that they "simply represented each family's shields". Further research proved that:

- 1-the images did not match any of the family's shields.
- 2-two different families would never use the same pattern.
- 3-these images do not match any shield of the era.
- 4-the images match well known and reported alien ships.



ARB  
DS



CCTV NEW YORK CITY, USA

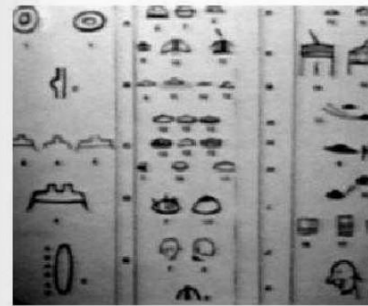
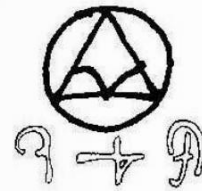

Pre-historic cave paintings in the south of France. The same ships can be found on wall cave paintings in Spain.



ARB  
DS

# ALIEN FILES

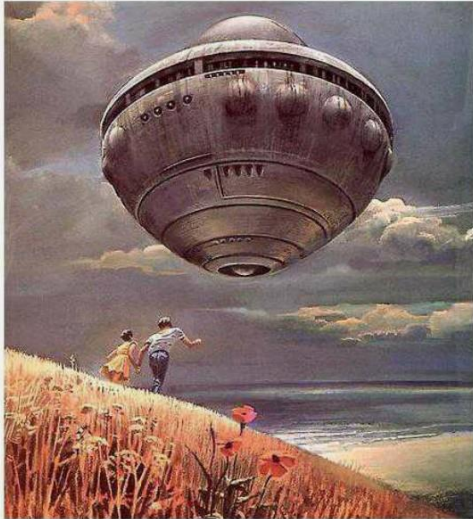

ARB  
DS

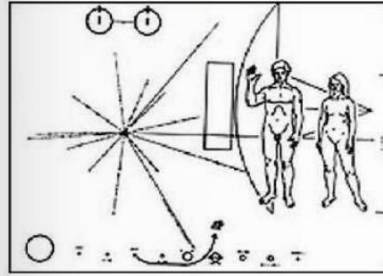

In 2003 the China National Space Administration (CNSA) received the reply from the Pioneer Plaques sent in 1972 and 1973 aboard the Pioneer 10 and 11. Despite many requests and offers from the USA, the EU, Australia and Russia for China to share the information on the reply, the Chinese have not done that yet.



In 1985, 3 alien races delivered documents and video to the UN Secretary-General Javier Perez de Cuellar showing evidence of several planets within Earth's solar system that had a daily average temperature of 32 degrees celsius (89.6 Fahrenheit) and oceans.



ARB  
DS



CASE 737  
LAFIA - NIGERIA

In August-21-1957 a caucasoid woman was found near Lafia.  
She was not dressed "matching" the area nor the time period..  
She was taken to a local Dutch land owner and "interrogated".  
Reports say that she claimed to be Captain Benjamin Briggs's  
wife Sarah...  
Captain Benjamin Briggs was the Captain of the Mary Celeste,  
a British-American merchant ship that was discovered on  
December-4-1872 in the Atlantic Ocean, unmanned and  
apparently abandoned.  
She committed suicide that same night.



ARB  
DS

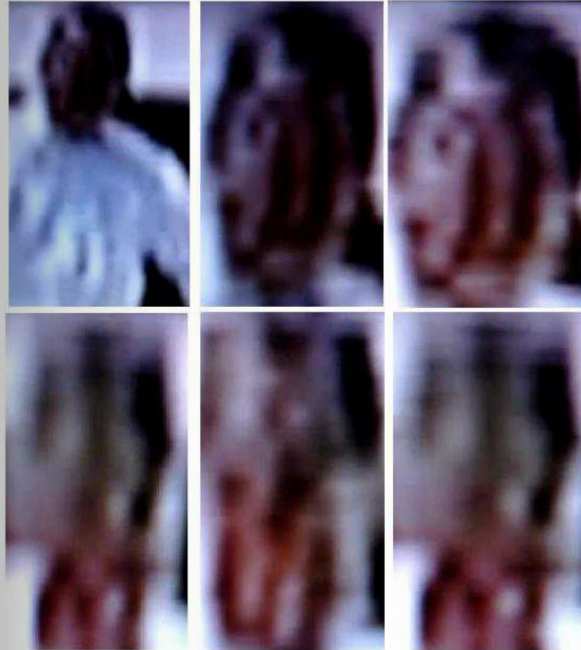

Reptilian shape-shifting in progress



ARB  
DS

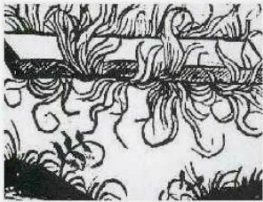

Europe 1465

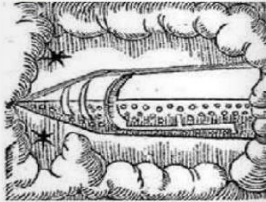

Arabia Peninsula 1479



Equador



Equador



Ukraine 4.000 BC



ARB  
DS

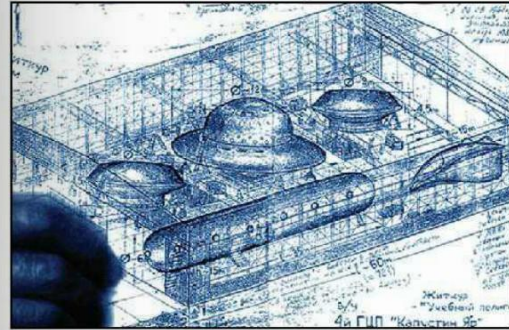

Recovered alien ships in the base of Kapushtin Yar, Astrakhan, Volgograd. 3 seemed abandoned, 2 the result of crashes.

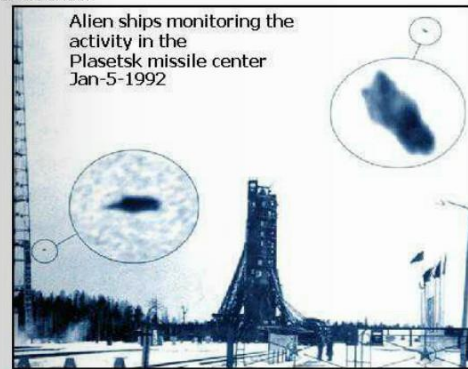

Alien ships monitoring the activity in the Plesetsk missile center Jan-5-1992









ARB  
DS

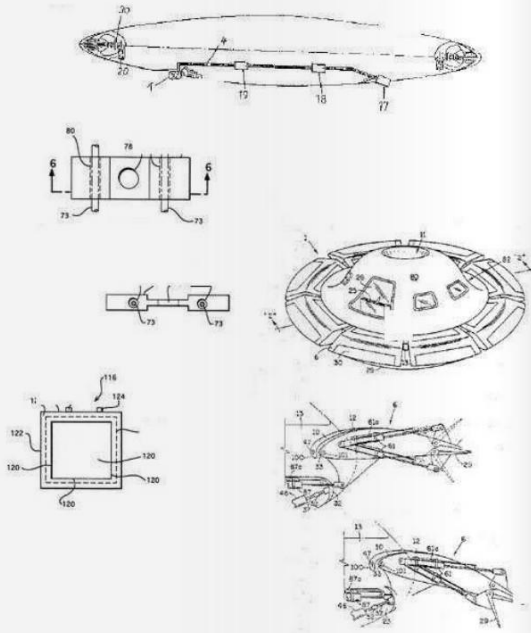

ARB  
DS

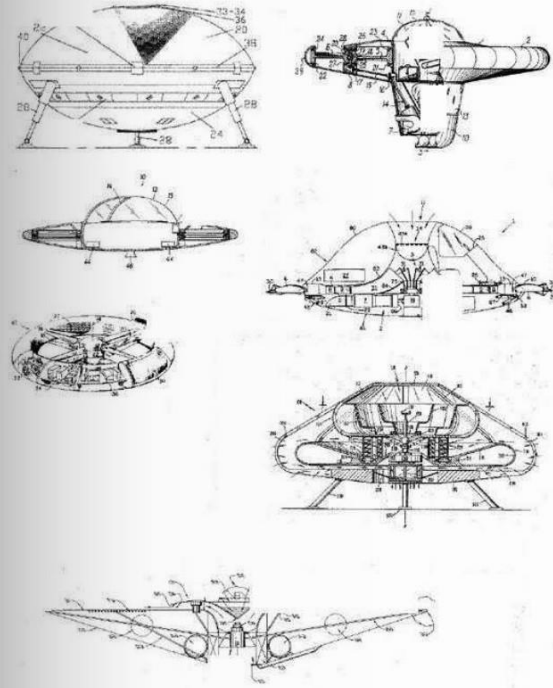



ARB  
DS



ARB  
DS

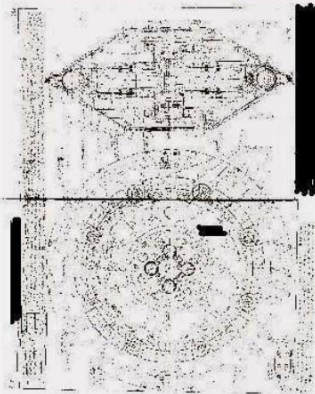

Photo (top) of AKART ship that crashed in Klisura, Bulgaria in 1971.

Left and bottom the USSR's (failed) attempt (for now) at recreating an alien ship.



We know that there are at least 2500 alien races...that number is likely to be much higher.

One race (a crew member of the MAZAREK ship that crashed near Yekatrinnburg, now Sverdlovsky) said that there are a few races that do not come to Earth because they know that the Reptilians and the Maitre are here...

Some of those races that avoid Earth are as violent (if not more) as the Maitre....others are peaceful.

So, having the Reptilians and the Maitre on Earth it is not always a bad thing...it keeps even worst races away.

The balance is "found" by having the "Council of 5" protecting us.

The MAZAREK crew member said the following:

"There are many more races that would like to protect Humans but they are not willing to start a war against Reptilians or Maitre over you..."





ARB  
DS

In the area known as the Bermuda Triangle there have been 2 permanent underwater bases for thousands of years.

The first one was established by the MATRAX around 3.000 years ago while the second one has been there for over 6.000 years...race unknown.

Several other races have had bases there (or near) but have abandoned them.



This photo shows the ruins of an abandoned base... APIS-USA used their influence in the media to propagate the rumor that it was a sank submarine. Later APIS-USA created a CGI video about it.

Remember: we cooperate with other APIS but we do not trust them or share information that is deemed confidential or top-secret.

00000000-0000-0000-0000-000000000000 1/1



ARB  
DS

We still have a very limited knowledge of the activities occurring in the Bermuda Triangle area.

From alien reports we do know this:

- 1- Abductions do occur in the area.
- 2- Experimentations with Humans do occur in those bases.
- 3- There is a "multi-dimensional space portal" that goes to and from the "Triangle" (not exactly inside the area known as the "triangle").
- 4- There is a race that is planning on building/creating a new base in the "Triangle" in the year 2021 (rumors say its the JIGHANTIK).
- 5- It is not the most important underwater region on Earth to those alien races.



00000000-0000-0000-0000-000000000000 1/1



ARB  
DS

These are some of the ships that were taken with the sole purpose (confirmed by 3rd party alien race) of abducting humans:

- "Pickering" 1800 (90 people), "Wasp" 1814 (140), "Grampus" 1843 (48), "Atlanta" 1880 (290), "Raifuku Maru" 1924 (?), "Stavenger" 1931 (43).



ARB  
DS

The crash of a Solipsi Rai ship in Roswell (USA) in July 7, 1947 has been one of the most secretive APIS-USA case. Despite our best efforts we were never able to recover any evidence except for the top-secret photos on anex-3352-B.



МИНИСТЕРСТВО БЕЗОПАСНОСТИ РОССИЙСКОЙ ФЕДЕРАЦИИ	Представлену Уголовно-следственной Ассоциации МГ
Центральной службы	Поговечу П.Р.
<u>18 июля</u> № П/А- <u>197</u>	10000, г. Москва, 3/1-30, "Филинград"
Москва	На № 1000 от 6 августа 1983 года
Собщию, что проведенной проверкой по материалам Централь- ного архива МГ не обнаружено горизонтальных материалов в случае процесса "свидетель торгачи" в районе г. Розвелл, США, в 1947 го- ду не обнаружено.	
Заместитель начальника архива	<i>Григорьев</i> В.П. Лусачанко



ARB  
DS

These are some of the ships that were taken with the sole purpose (confirmed by 3rd party alien race) of abducting humans:

- "Pickering" 1800 (90 people), "Wasp" 1814 (140), "Grampus" 1843 (48), "Atlanta" 1880 (290), "Raifuku Maru" 1924 (?), "Stavenger" 1931 (43).



ARB  
DS

The crash of a Solipsi Rai ship in Roswell (USA) in July 7, 1947 has been one of the most secretive APIS-USA case. Despite our best efforts we were never able to recover any evidence except for the top-secret photos on anex-3352-B.



МИНИСТЕРСТВО БЕЗОПАСНОСТИ ВОЗДУШНОЙ ФИДЕРАЦИИ	Представлену Уголовно-следственной Ассоциацией СМ
Центральной службы	Поговечу П.Р.
<u>18.04.53</u> № П/А- <u>197</u>	10000, г. Москва, 3/11 ЗС, "Филинград"
Москва	На № 1000 от 6 августа 1953 года
Собщию, что проведенной проверкой по материалам Централь- ного архива СМ не обнаружено горизонтальных материалов в случае процесса "свидетель торгачи" в районе г. Розвелла, США, в 1947 го- ду не обнаружено.	
Заместитель начальника архива	<i>Ген</i> В.П. Лусачанко







ARB  
DS

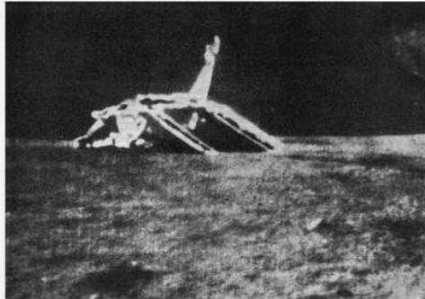

There's more than 1 race conducting operations on the Moon...  
The main race in the Moon are the INDUGUTK (aka "Tall White").

The MYTHILAE also have at least 1 base (surface) on what we call "the dark side" of Earth's satellite.

Many of the INDUGUTK human abductees are there...they end up either as slaves for mining (underground) or as what they call "John's" and "Mary's"...but their "official" name is: "students-M".

The "students-M" are abductees that reveal a higher level of intelligence and are willing participants (or become that) in their agenda and plans.

It is estimated that 4 in each 10 abductees become "students-M".  
The rest (60%) become slaves. Some of those slaves go on to work on other planets.

The "students-M", after "training" (and whatever else). return to Earth to assume leadership roles in Human society.



ARB  
DS

HOW MOST ALIEN BASES ON THE MOON ARE BUILT

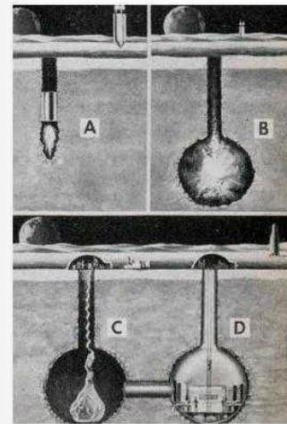

AND HOW SOME LOOK FROM ABOVE

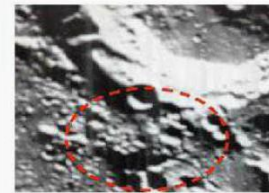



ARB  
DS

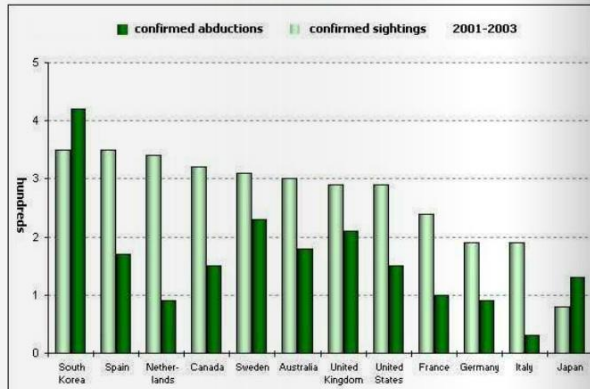

IN RUSSIA (SAME PERIOD)  
sightings: 425  
abductions: 156

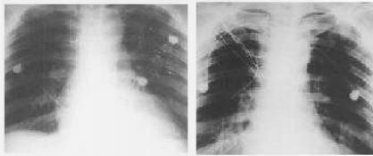

ALIEN IMPLANTS in APIS-RUSSIA AGENT



ARB  
DS



#### THE DAY HUMANS KILLED REPTILIANS

In 856 BC, in the region of (now) Udmurtia, Russia, there was a confrontation between Humans and Reptilians.

Reports state that a colony of Reptilians were building an underground base in the area. The Humans that lived in the area wrote:

"Thunder by day, lightning at night...the earth shakes like in the days of old again...the snakes are everywhere, flying low and causing all creatures to die...the fish are gone and the rivers dry...we must fight or we will die."

A member of the TENGRI-TENGRI, when asked by a Human leader (in the 20th century) if we Humans would ever have a "fighting chance" at defeating the Reptilians, said:

"Your ancestors from ancient Slaviae using not much more then stones and sticks defeated them once already...since then you have learned much and done much...but you have lost your courage..."



ARB  
DS



ARB  
DS

The TENGRI-TENGRI did say that there's a rumor that the Humans did not act alone against the Reptilians...that they had an alien race helping them "behind the curtains"... However they also said that in the moment of battle supposedly there were only Humans fighting, not aliens. Either way, it shows what Humans can do and that "nothing is lost"...

For posterity those Humans made these works of Art, a reminder of a great day for their culture...

One thing though: the story goes that 200 years later that culture simply vanished...

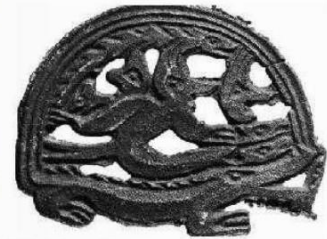





ARB  
DS

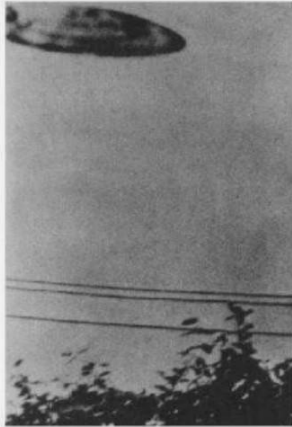

ARB  
DS

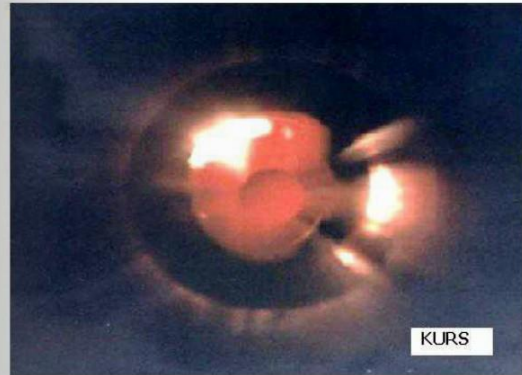





ARB  
DS

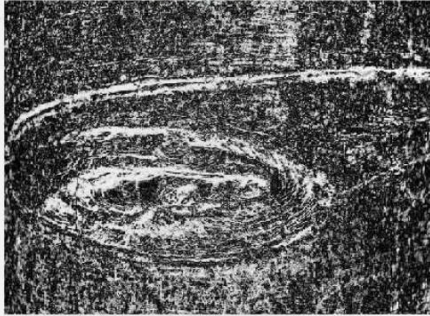

DAY OF SHAME  
THE TUNGUSKA EXPLOSION

The Tunguska "incident" was a powerful explosion that occurred in a desolate area near the Tunguska River in Russia, on June 30, 1908.

It is commonly believed to have been caused by the explosion of a large meteoroid in Earth's atmosphere about 5-10 Km (3-6 miles) high.

The blast flattened an estimated 60 million trees over 2,150 square kilometers.

But the Tunguska explosion did NOT have a cosmic birth and death...

Here's the version of events that led to the explosion...as told by a member of the TENGRI-TENGRI:



ARB  
DS



"For 5 days and 4 nights, near what you call Tunguska, the MAITRE had been fighting the DORSAY.

Other races were starting to choose "sides" and were going to get involved. Even the "Council of 5" was worried with the escalation and seriousness of the event...

On the day of that great explosion an EL-MANOUK ship came to Earth in order to try ending the conflict...the EL-MANOUK are respected wherever we may go...they are wise and impartial. With them came a PLEYADIYAN ship...one of their biggest.

The Maitre were warned by the Reptilians of the coming presence of the El-Manouk and the Pleyadiyans...Earlier that day the Maitre had just shot down the last of the Dorsay ships...

When the Pleyadiyans entered Earth's atmosphere they were attacked by 3 Maitre ships and destroyed. One El-Manouk ship was also destroyed in space that day... And that is what happened in Tunguska."



ARB  
DS

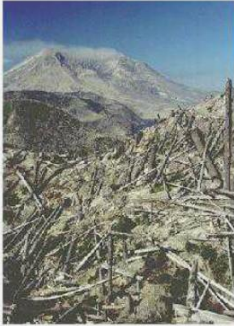

THE DEVASTATION IN TUNGUSKA



ARB  
DS

Also according to the Tengri-Tengri:

"The Pleyadiyan ship that was destroyed that day near Tunguska was not supposed to come to Earth that day...they were going to a different destination, carrying the things they do...their Holy Rocks and other materials...the El-Manouk asked them to help them in solving the conflict...and they paid the price with the ending of this life of theirs..."

In 2003 crystals with strange symbols, inscriptions and holes were found in the Tunguska region...further lab analysis showed that their composition is made of certain Earth minerals as well as some elements that are not found on Earth.



(NOTE OF MYSELF AND PETRO: in late 2008 the crystals were presented to the media by a Russian scientist. After much discussion about the origin of the crystals, the matter lost interest and it is supposed that the crystals now rest in a private collection)



ARB  
DS

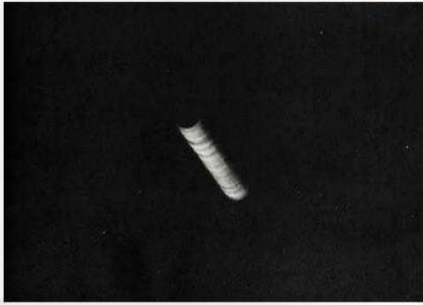

ARB  
DS

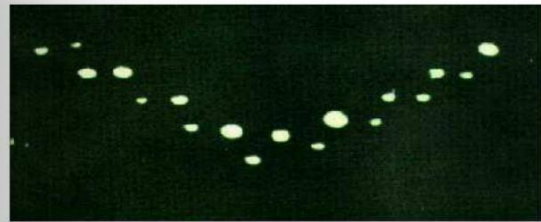



ARB  
DS



ARB  
DS





ARB  
DS

The CHULKAE (as aliens call them) are NOT an alien race as commonly accepted for many years by different APIS. Aliens do not know how they evolved or where they came from.

The only things we know about them are: They exist in all continents, they live underground and are mostly nocturnal, they have a structured society (leaders and social classes), they have a cultural identity and supposedly they can live up to 250 years.

None was ever captured alive...



ARB  
DS



CASE 34-8-NB  
Illichivsk (ODESSA) - UKRAINE

In October-2-1947 a confirmed Maitre landing happened...2 days later 12 sailors (on a fishing boat) disappeared.

In 1982 one of the missing sailors (a Mr. Kyrilo, in 1947 only 16 years old) showed up in Maardu, Estonia.

He reported that he had been "in the Moon".

He died in 1983 from a self-inflicted wound.

On his chest he carved (with a knife) the following:

"SS Waratah...they are still waiting..."







ARB  
DS

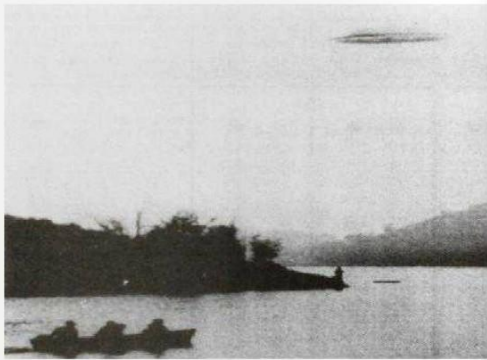

ARB  
DS

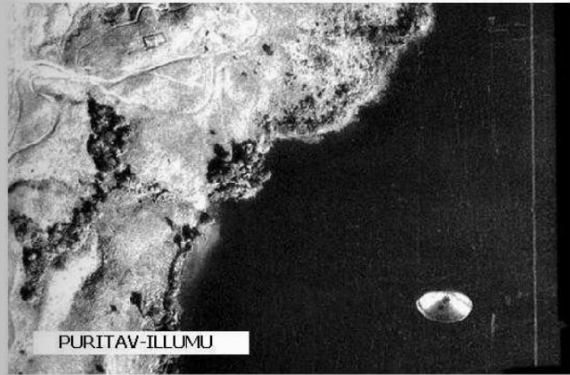



ARB  
DS



CASE 556-9-IOP  
(Oregon)

HMS Sickle was a submarine of the Royal Navy.

In June 12 of 1944 it went missing while on patrol in the northern Aegean...

One member of the crew was found in 1971 near Bend, Oregon.

In 1984 he became an advisor to USA President Ronald Reagan and he was often seen in the company of Minnesota Governor Harold Stassen.

As far as we have been informed he is still alive.



ARB  
DS



LIST OF AMERICAN POLITICIANS WITH  
CONNECTIONS TO THE REPTILIANS  
(confirmed)

- Former U.S. Secretary of Defense Donald Rumsfeld
- Former vice-President Dick Cheney
- Former President George H. W. Bush
- Former President George W. Bush
- Former Secretary of State Henry Kissinger
- Former President Bill Clinton





ARB  
DS

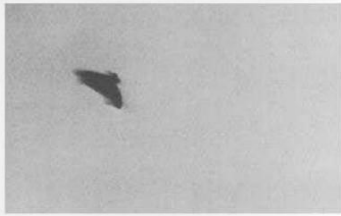

ARB  
DS





ARB  
DS

# ALIEN SHIPS



© 2000-2001 ARB DS. All rights reserved. 1/1



ARB  
DS



© 2000-2001 ARB DS. All rights reserved. 1/1



ARB  
DS



PLEYADIYAN

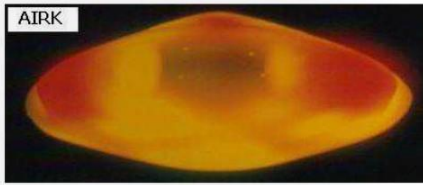

AIRK

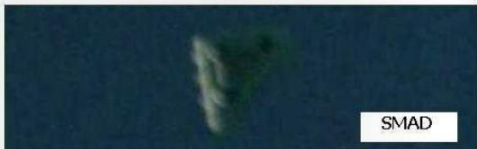

SMAD



ARB  
DS

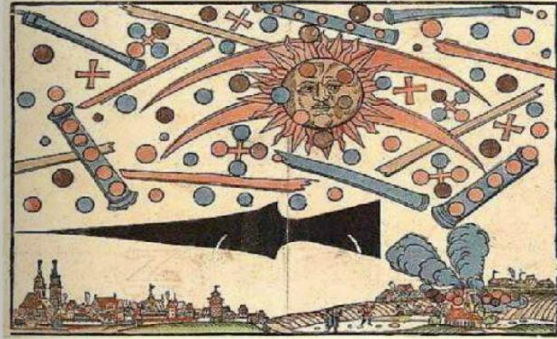





ARB  
DS

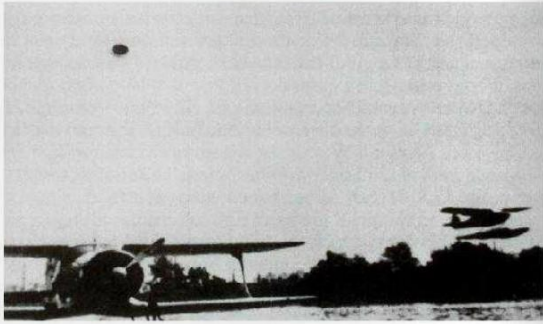

ARB  
DS





ARB  
DS

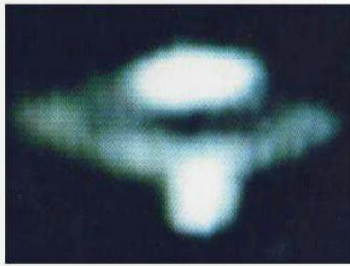
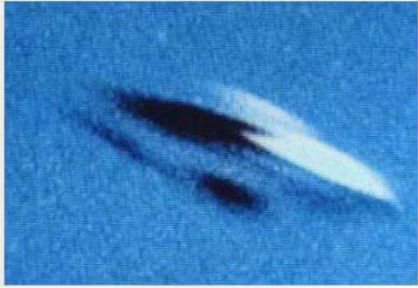

ARB  
DS

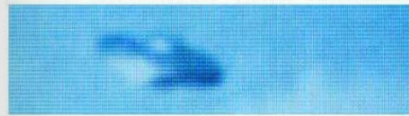



ARB  
DS

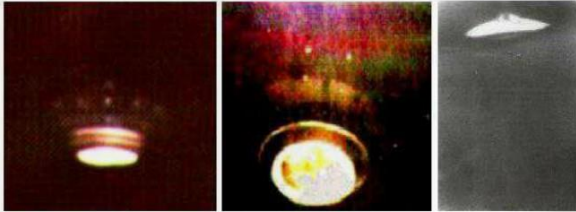

KURS

KURS

†  
M  
T  
E  
S  
K



ARB  
DS





ARB  
DS

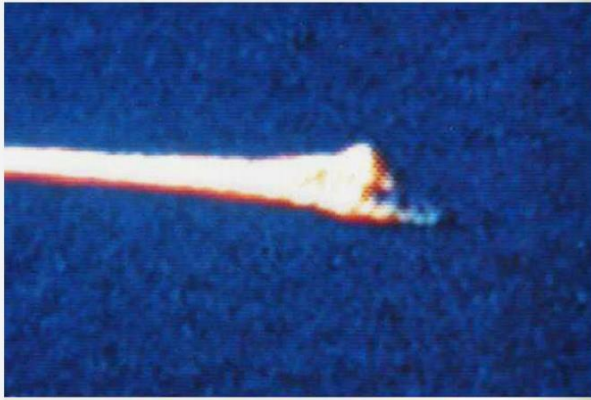

ARB  
DS



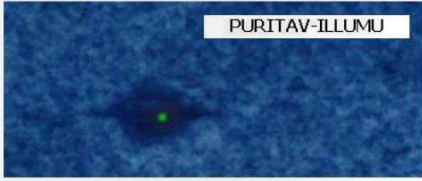

PURITAV-ILLUMU

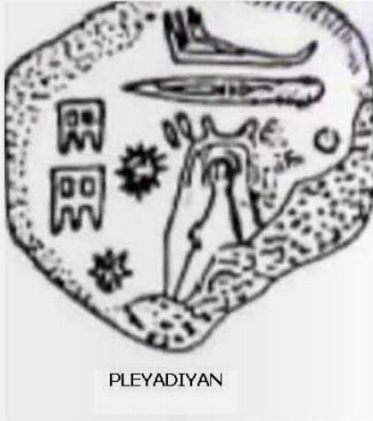

PLEYADIYAN

ARB  
DS

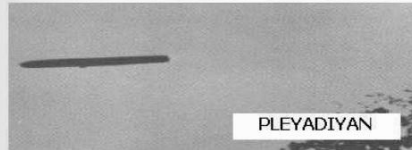
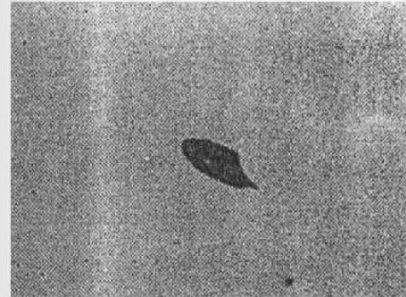
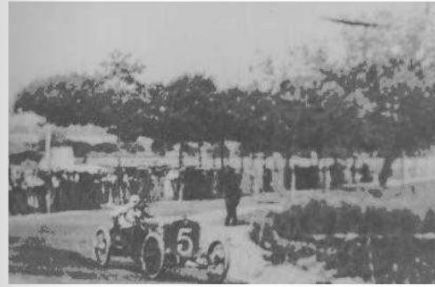

PLEYADIYAN

ARB  
DS





ARB  
DS

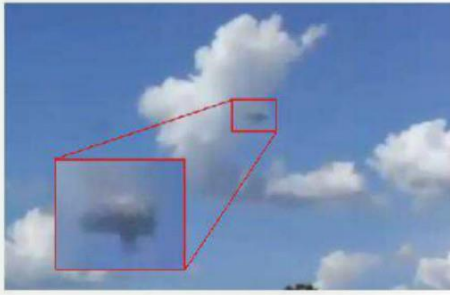

ARB  
DS

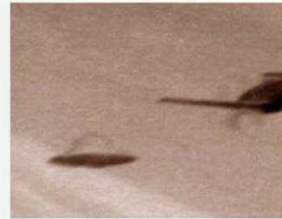
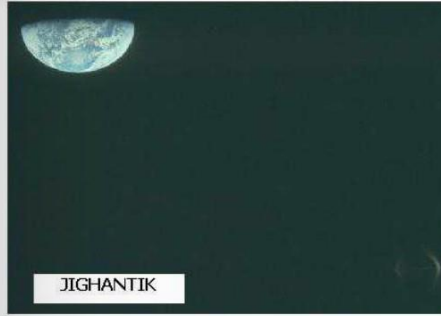

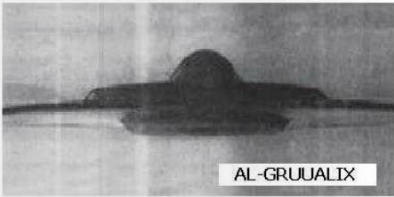

ARB  
DS

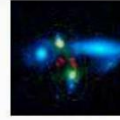

ARB  
DS



ARB  
DS



MAZAREK



ARB  
DS



KIILY-TOKURT



ARB  
DS



Source: https://www.youtube.com/watch?v=...



ARB  
DS

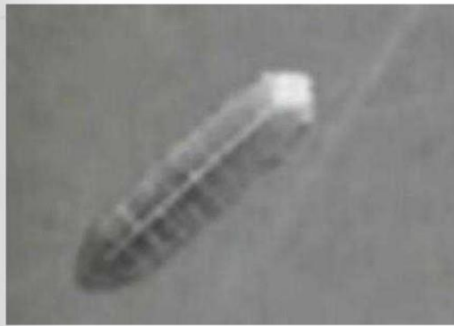

Source: https://www.youtube.com/watch?v=...



ARB  
DS

# ALIEN DIXIT

THE FOLLOWING ARE QUOTES, PERSONAL MESSAGES (FACE-TO-FACE) AND/OR TRANSMISSIONS FROM SEVERAL ALIEN RACES OBTAINED VOLUNTARILY AND/OR UNDER CUSTODY AND DISTRESS.

THEY WERE OBTAINED BY SEVERAL DIFFERENT APIS (ALIEN PRESENCE INTELLIGENCE SERVICES) FROM AROUND THE WORLD, BUT MAINLY FROM THE USSR, RUSSIA, USA, CHINA AND JAPAN

THESE STATEMENTS DO NOT EXPRESS THE OPINION OF ALL ALIEN RACES ON ANY OF THE MENTIONED ISSUES, IN FACT THEY DIFFER SUBSTANCIALY ON SOME ISSUES, SPECIALLY WHEN DEALING WITH THE FUTURE OF THE HUMAN RACE

© 2017 ARB DS. ALL RIGHTS RESERVED. 1/1



ARB  
DS

- 5 UNIVERSES, 2500 SPECIES, 1 RACE

- THE VIOLENCE AND HATRED THAT HUMANS HAVE INSIDE THEMSELVES, WHEN COMPARED TO THE VIOLENCE AND HATRED THAT THE RACE MAITRE HAS INSIDE THEMSELVES, IS LIKE COMPARING A FLOWER TO A VOLCANO

- IN 2017 YOU WILL SEE THE BEGINNING...IN 2022 YOU WILL SEE THE BEGINNING OF THE END. UNLESS YOU ALL CHANGE...

- ILLUMINATI PESTIS

- WE HAVE GIVEN YOU SO MUCH AND YOU HAVE GIVEN YOURSELVES SO LITTLE...

- SPACE AND TIME ARE NOTHING, WE ARE NOTHING...SHE IS EVERYTHING !

- THERE ARE 834 KNOWN SPECIES AT THE SAME LEVEL THAT YOU HUMANS WERE 3000 YEARS AGO...AND THEY ARE NOT VERY FAR AWAY FROM YOU...WE HAVE SHOWN YOU TO SOME OF THEM, LIKE WE HAVE SHOWN SOME OF THE OTHERS TO YOU...NOW AND THEN, AND THEY ARE AFRAID OF YOU, OF WHAT YOU MAY BECOME.

- THE SIGNS ARE ALL AROUND YOU, AND ABOVE YOU, AND INSIDE OF YOU...IN THE FIELDS, THE SKY AND THE STARS...AND IN THE EYES OF YOUR CHILDREN AND YOUR OLD ONES.

- OF ALL SPECIES WE HAVE FOUND IN 3 UNIVERSES YOU ARE THE ONE WITH MOST SUICIDAL THOUGHTS





ARB  
DS

- YOUR PLANET ONLY HAS LESS THAN 1% OF WHAT MANY RACES THAT VISIT YOU WANT OR NEED...BUT YOUR PLANET IS IN THE RIGHT PLACE TO ALL OF THEM...
- THE IMPORTANCE THAT 1000 RACES GIVE TO YOU IS THE SAME THAT YOU GIVE TO 1 GRAIN OF SAND IN THE DESERT...YOUR PLANET JUST HAPPENS TO BE IN THE RIGHT PLACE ! SOMETIMES THE WRONG PLACE...
- YOU HUMANS HAVE BEEN MISLEAD AND YOU GREW UP TOO FAST
- JUST LIKE YOU LEARN TO LOVE A STRANGER AFTER YOU MEET HIM, SOME OF US HAVE LEARNED TO LOVE YOU...
- WE WILL ALWAYS PROTECT YOU, UNTIL THE DAY YOU SAY "NO MORE".
- WE CANNOT PROTECT YOU EVERYDAY...THERE ARE 5 KNOWN UNIVERSES IN 5 DIFFERENT DIMENSIONS TO PROTECT.
- YOUR WORLD IS FULL OF LINES, FOLLOW THEM...
- THE "COUNCIL OF 5" WILL BECOME THE "COUNCIL OF NONE" ...AND THEN YOUR PLANET WILL FACE THE "COUNCIL OF DEATH"
- NO OTHER RACE RIDICULES OTHER RACES AND EACH OTHER LIKE YOURS DO...
- SOON 1 YEAR WILL FEEL LIKE 1 MILLION TO YOU
- AND IN GREECE YOU WILL FIND YOURS AND OUR PAST



ARB  
DS

- WE, THE MAITRE, WILL BE THE NEW "SHE" ...
- YOU BELIEVE IN MANY THINGS THAT YOU DO NOT SEE EXCEPT FOR THE ONLY THING YOU DO NOT SEE BUT SHOULD BELIEVE IN...AND IT HAS ALWAYS BEEN ALL AROUND YOU...YOU JUST CHOSE TO FORGET IT !
- THERE IS MUCH WORST THEN THE RACE MAITRE...WE KNOW IT, WE HAVE SEEN THEM AND WE HAVE SEEN WHAT THEY HAVE DONE...AND THEY KNOW ABOUT YOU HUMANS...
- THERE ARE SO MANY OF OURS IN YOU...
- THERE ARE MANY OF US THAT YOU ADORE IN PLACES THAT YOU ADORE...AND IN PLACES THAT YOU HATE.
- WE COULD STOP YOUR SUN FROM RISING TOMORROW
- 500 YEARS AND YOU ARE STILL LYING TO EACH OTHER...
- SOON THIS DREAM OF YOURS WILL END...
- YOU HAVE LOST 1000 YEARS IN THE PAST 50 YEARS
- IF YOU GO TO MARS, MARS WILL COME TO YOU...THAT IS WHAT THEY DO.
- YOUR CHILDREN THAT NOW LIVE INSIDE THE MOON DO NOT MISS YOU ANYMORE
- THOUSANDS OF YOUR CHILDREN GO MISSING EVERY YEAR, NEVER TO BE FOUND AGAIN...AND YET YOU STILL EXPECT YOUR TELEVISION TO SAVE THEM WHEN INSIDE OF YOU YOU ALREADY KNOW THE ANSWER.



ARB  
DS

- REPTILIANS AND MAITRE KILLED HIM...WITH YOUR HELP !
- INNOCENT SECRET SECTS AND MALEVOLENT SECRET SECTS...AND YOU ADORE THEM BOTH..."SHE" IS NOT INSIDE OF YOU ANYMORE...
- WE HAVE DIED FOR YOU AND STILL YOU FEAR US...
- WHY THREATENING US IF WE CAME TO YOU OFFERING YOU LONG LIFE ?
- YOU KILL EACH OTHER EVERYDAY IN THE NAME OF SAVING EACH OTHER...AND YOU HAVE BEEN DOING THAT SINCE BEFORE WE TALKED TO YOU.
- THE ANUNNAKI CREATED YOU ONCE...THEY WILL NOT CREATE YOU AGAIN...WE WILL DESTROY YOU AND THE ANUNNAKI...AND THE TIME IS NEAR...
- 8 YEARS IN 1 DAY...8 YEARS IN 1 DAY...8 YEARS IN 1 DAY...
- ALMOST ALL RACES WENT TO WAR, BUT NOT WITH THEMSELVES...
- YOUR MODERN GODS ARE CONFUSED...YOUR ANCIENT GODS ARE FORGOTTEN.
- LOOK AT THE STARS AND YOU WILL SEE US EVERYDAY LOOKING AT YOU.
- IF YOU LOOK TOO FAR YOU WILL SEE SOMETHING YOU DO NOT WANT TO...



ARB  
DS

## THE NOTES & UPDATES





ARB  
DS



"The Kurs showed up again...washington, DC"  
"The Kurs are not supposed to be here...what is going on?"  
"Pleyadians in bora-bora...APIS Russia and USA ignored them...again!"  
"Why did the Maitre accepted guilt for 2000?"  
"More planes are being ready for 2017..."  
"Bush will do what Bush is told...like the one's before him"  
"3 more economies destroyed...why don't people see it??"  
"In August-2013, USA, try Alfalfa Market Road in Oregon"  
"Want to see? watch: 54.7371° N, 55.9667° E - August 27"  
"JFK had DNA from the First race !!!!! Call Yakim-3 !!!"  
"Why did they chose Putin to start the avalanche?"  
"The black will be white and the yellow will be red"



ARI  
DE



(NOTE FROM MYSELF AND PETRO)

THESE ARE SOME OF THE HAND WRITTEN NOTES AND UPDATES FOUND ON THE ALIEN RACES BOOK PAGES.

THERE ARE LITERALLY HUNDREDS OF THEM...ABOUT 3 OR 4 IN EACH PAGE.

WE CHOSE THE ONE'S THAT WE DEEMED MORE RELEVANT...

OTHERWISE THIS PUBLICATION WOULD HAVE THOUSANDS OF PAGES...

WE MAY ONE DAY PUBLISH ALL NOTES.





ARB  
DS



"As Napoleon, Alexander and Hitler did, so will the rest!"

"How blind are people that they cannot see what's in the Grand Canyon?"

"Connect London, Berlin and Cairo..."

"2 km's south from the Vatican...small pink house...always for rent, never rented...they keep it there!"

"Charola dos Templarios..."

"Why do Australian Humans do not see September 23 ?"

"Caravaggio has it"

"The Pope and Castro met again last week...with Maitre!"

"The States are loosing ground now..."

"Funny...Putin using Medvedev in front of everybody...ha ha ha!!!"



ARB  
DS

# SHE





ARB  
DS

Ever since Humans and aliens started cohabiting Earth, the main question Humans wanted answered was:

"Who created the Universe and all of us?"

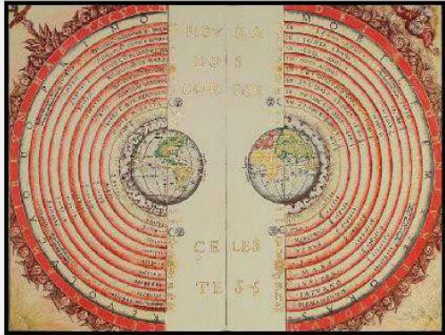

That question has been answered the same exact way by all the alien races that have spoken about it...

The answer to that question has been sent several times, by 2 different races, to ALL Human religious leaders throughout the centuries...

The answer to that question has been sent several times, by 2 different races, to SOME Human political leaders throughout the centuries...as far as we know the last of those leaders to get the message was USA President JFK in October 3, 1963.



ARB  
DS

THE MESSAGE WAS SENT BY THESE 2 RACES



RAMAY



JEFOK

THE MESSAGE IS BOTH SIMPLE AND COMPLEX...

INFORMATIVE BUT RAISING QUESTIONS...

OF HOPE BUT ALSO OF WARNING...







ARB  
DS



RAMAY

JEFOK

AND THIS IS THE MESSAGE:

"This is a message of disambiguation to all of you men of the Human kind.  
 This is a message of redirection to all of you men of the Human kind.  
 This is a message to enliven the minds of you men of the Human kind.  
 This is a message that has been delivered from race to race since the Beginning...just like it was delivered to us, it is now passed to you...  
 Where there were no men of the Human kind there were others of other kinds..."



ARB  
DS



This is a Message to you as well, Women of the Human kind.

Only the First race has Her purity...

All other races must live the grievous, patient and laborious process of spiritual inner discovery and progression.

Your (Our) collective History and Memory has suffered much in the Past...it has been erased, manipulated, suffocated, shifted, changed and molded according to the interests of a few.

On your Planet as well as on Ours and the one's of other kinds in the Past...

To the leaders of Kingdoms and Countries and Regions: look at your religious leaders...

To the religious leaders: look at yourselves and the one's like you, leaders of other religions, all over your Planet...

Why do you wear your long robes and skirts, and all manners of Symbols that you do not understand ?

Why do you, religious leaders, men of the Human kind, wear your long robes and skirts not knowing why?

Who, men of the Human kind, are you trying to be?

Who, men of the Human Kind, are you trying to represent?





ARB  
DS

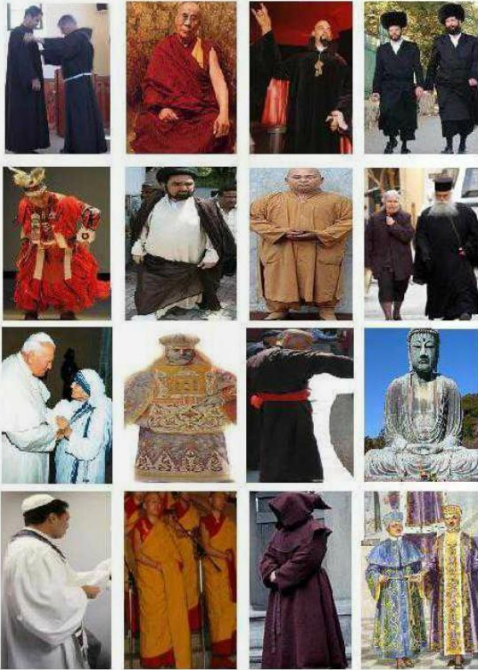

this page (and images) is not original to the book. It was added by myself and Petro to serve as an illustration.



ARB  
DS



You, religious men of the Human kind, and you, leaders of Kingdoms and Countries and Regions, men the Human kind, have slowed your spiritual progress in half because you have divided your kind in half...

No men of the Human kind should destroy what the women of the Human kind have created.

You have for many of your years relegated the women of the Human kind to the role of slaves.

And before your kind, many other kinds have done that...and before your kind, men of the Human kind, many other kinds we have warned.

For you to achieve what is Yours, for you, Men and Women of the Human kind, to be closer to Her, you must first become one kind.





ARB  
DS



Like many kinds before you, Men and Women of the Human kind, you have a journey of restraint and constriction ahead of you...a journey of difficulty and resistance.

But, unlike many kinds before yours, you are on a path of spiritual self destruction never experienced or self provoked by the other kinds before...

And yet, you are so young...

The Anunakene created you...but many kinds can destroy you.

You have 2.000 more (of your) years to change...after that, men of the Human kind, it will be too late.

Not too late for your survival BUT too late for your salvation !

Your spiritual salvation...

The "Council of 5" can only keep you safe from other kinds, NOT from yourselves...



ARB  
DS



And we know that you have been betrayed, misled and mistreated...

And we know that after thousands of (your) years, by means of infiltration, disguise and deceit, you, men of the Human kind, have been fooled to believe the unacceptable by races that do not wish you well...

But, before you, many others kinds suffered the same...and they too overcame what seemed impossible to overcome...

Your strength is inside of you and all around you...even now !

Your strength is in Her...and She is inside YOU, men and women of the Human kind...even now !

And the Answer is in the place that you, Human-kind, call Greece.

And the answer is She... Artemis, Diana.

And the answer have always been Her...

And the answer, men and women of the Human kind, has been the same to all kinds...in all places!





ARB  
DS



Some accept it, others don't...but the answer is only one: She!  
It has been this way from the beginning and it will be this way,  
men and women from the Human kind, until the End...

It has been this way here and in all 4 universes and dimensions.

"She" has many names...and many faces...and lives in many  
places... "She" is the Creator, NOT the destroyer...

In your planet She was and is called Diana...or Goddess Diana...in  
our planets she was called Alixi...

She was also called (on other Planets) Lexae, Lixae, Dixae and  
Tixae...

To you, of the Human kind, she will always be Goddess Diana.

"Search" for Her, learn of and from Her...She is the TRUTH, the  
Light, the Beginnig and but never the End, the Creator and never  
the Destroyer... The ONE all of us came from.

And learn from your legendary Greek "Gods" of old...as they all  
did exist...as you exist and we exist.

And we are one...and She is the One!

SHE is the One that you, religious men from the Human kind, lost  
in your robes and memory, want to be and try to replicate ...

Men of the Human kind: learn from Her...the Creator !"



ARB  
DS







LIST OF POPES TO WHOM THE MESSAGE  
HAS BEEN TRANSMITTED TO



Cornelius - 3rd century



Miltiades - 4th century



Callixtus II  
12th century



John VII - 8th century



Pius VII  
19th century

John Paul I - 20th century



LIST OF ISLAMIC LEADERS TO WHOM THE MESSAGE  
HAS BEEN TRANSMITTED TO



- Allamah Majlisi Sani, 1690
- Ibrahim al-Fayyumi, in 1725
- Mustafa al-Arusi, 1864
- Mustafa al-Maraghi, 1935
- Gad al-Haq, 1982







ARB  
DS



ARB  
DS

## FINAL THOUGHTS

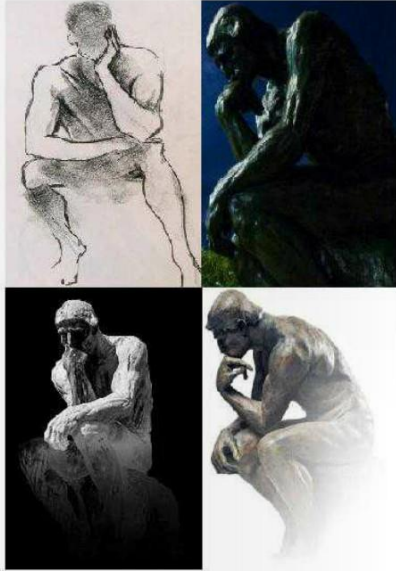

The future of the Human race is NOT in our hands at this point in time...one day it might be.

All that we, real Humans, can do right now is to gather all the information we can about these alien races and their habits, to find out about their weaknesses and strengths, so that when our future becomes our responsibility we can be prepared to fight for it if needed.

Today we are just mere spectators watching a "theatre play"... some of us are watching the "play" completely unaware that what we are watching is real...the actors (aliens) are real...the "play" (story-line) is real...the "stage" and the "props" (alien worlds, alien ships and odd cosmic events) are real...

Others know that what they are watching is real...but there's nothing that they can do about it...they cannot change the "play"...and certainly they cannot go to another "theatre" where the "play" is more of their liking...the only thing they can do is watch!

Others (like you, me, your companion agents and a few more world wide) are spectators taking "notes" about what is in front of them...about the "play", about the "actors" and about the "setting" and "props"...we are learning about and writing about everything we see...so that one day when we have an opportunity to change the "story-line", we are prepared to do so...

But beware...amongst the spectators there are many that are not paying attention to the "play"!

They are only watching the other "spectators" around them, specially the one's "taking notes"...and those spectators look just like you and me...they can be seated right beside you...sometimes they even are the one's that gave you the ticket for the "play"...and sometimes they are your own parents!



LATEST UPDATE TO THE BOOK  
(added by myself)

One of stages used by  
Pope Francis during his  
visit to Brazil July 2013

